

Emrys Solar PV Flexible Modules

Installation and User Manual

This manual applies to Photovoltaic Flexible Modules (hereafter referred to as “Modules”) manufactured by Emrys Solar Co., Ltd. (hereafter referred to as “Emrys”). Professional skills and knowledge are required for the installation. Only qualified installers after proper training can assume this job. Installers should follow all safety precautions described in this manual as well as local codes when performing installation and maintenance.

1. INTRODUCTION

Thank you for choosing Emrys as your PV module provider. You must read carefully and be familiar with this manual before handling, installing, and/or maintaining. This manual contains important information such as safety, installation, maintenance of modules, and other relevant information.

This manual is not in a form of any types of warranty document, expressed or implied. It does not stipulate compensation scheme of any loss, damage or other expenses caused by or generated during module installation, operation or maintenance. Emrys assumes no responsibility for any infringement of patents or other rights of third parties, which may result from using Emrys modules. Emrys reserves the right to make changes to its products or this manual without prior notice.

Emrys is not responsible for any damages caused by inappropriate installation, use, or maintenance of Emrys modules, including without limitation damages, losses, and expenses caused by non-observance of the instructions of this manual or caused by or in connection with products of other manufacturers.

Failure to comply with the requirements listed in this manual will invalidate the Limited Warranty for modules as provided by Emrys at the same time of sales to the direct customers. Additional recommendations are provided to enhance safety practices and performance results. Please provide a copy of this manual to the PV system owner for their reference, and inform them all relevant aspects of safety, operation and maintenance.

This Installation and User Manual is available in different languages. In cases of discrepancy between versions, the Chinese language version shall prevail.

2. CODES AND REGULATIONS

The mechanical and electrical installation of PV systems should be performed in accordance with all applicable codes, including electrical codes, building codes, and electric utility interconnect requirements. Such requirements may vary for mounting location. Requirements may also vary with system voltage, and for DC or AC application. Contact local authorities for detailed governing regulations, acquire confirmation and relevant permission.



3. MODULE INFORMATION

3.1 Encapsulation structure drawing

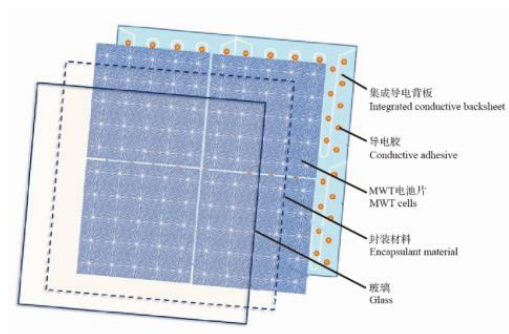

3.2 Module drawing

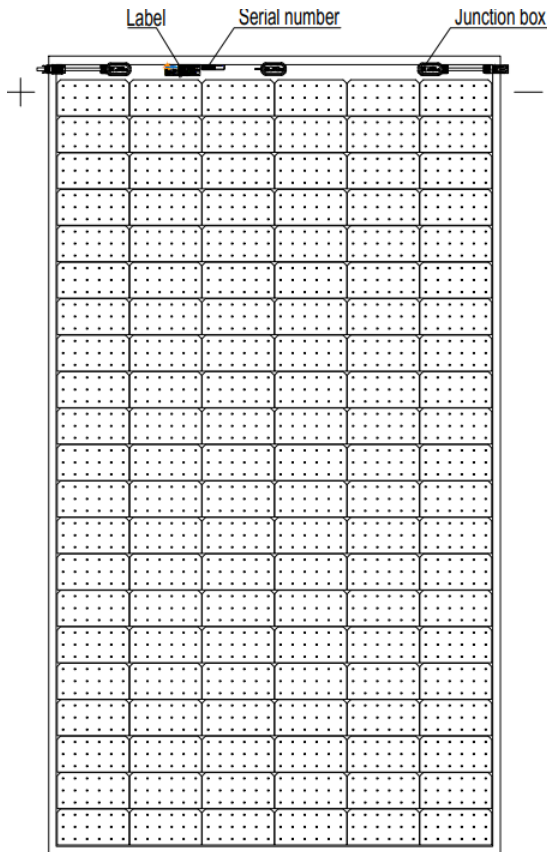

storage until they are ready to be installed. Protect it against damage during transportation. Secure the pallets from falling over. Do not exceed the maximum stack height limit when stacking as indicated by the symbols outside the package. The package shall be stored in a cool and dry location until the modules are ready to be unpackaged. The modules shall be handled. Never use the junction box or cables as a grip. Do not exert mechanical stress on the cables. Never step on modules or drop or place heavy objects on them. Be cautious when setting the modules down onto a surface, especially on the corner of the modules.

4.2 Operating safety

When unpacking the modules from the original package, first remove the pallet lid (after removing securing straps, if provided). Remove one module at a time. You may need to secure the remaining modules in the original packaging and prevent them from falling over.

Check modules for damage due to transportation before they are installed. Do not install damaged modules. Contact with us if you need to make claim of the defective products.

Do not attempt to remove any part from the modules; do not apply paint to or stick labels on the module surface; do not scratch on module front sheet to avoid any damage. do not attempt to disassemble or modify the modules for your safety. This may have negative effect on the module quality and safety, even irreversible damage. Additionally, all the warranty will be not available.

4.3 Electrical safety

In case that no load or external circuit being connected, photovoltaic modules can produce DC electricity when exposed to light and therefore can produce an electrical shock or burn. DC voltage of 30 Volts or higher is potentially lethal. Please use insulated tools and rubber gloves when working with modules in sunlight.

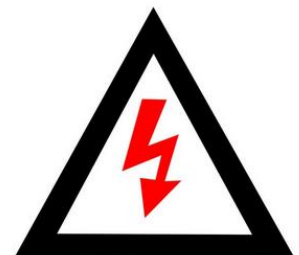

Modules have no on/off switch. Modules can be rendered inoperative only by removing them from sunlight area, or by fully covering their front surface with cloth, cardboard, or other completely opaque material, or flipping Modules, and placing the front side of Modules onto a smooth, flat surface.

In order to avoid arcs and electrical shock, please do not disconnect electrical connections under load. Faulty connections can also result in arcs and electrical shock. So please keep connectors dry and clean, and ensure that they are in proper working condition. Never insert any other metal

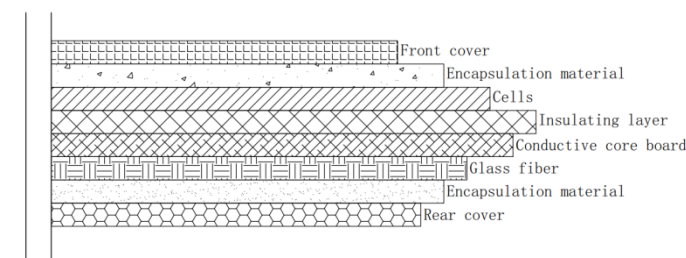

3.3 Nameplate

The nameplate describes the product type, peak power, the maximum power current, the maximum power voltage, open circuit voltage, short circuit current, the maximum system voltage and certification marks and etc. All of above are measured under standard test conditions.

4. SAFETY

Emrys's Flexible modules are designed to meet with the requirements of IEC 61215 and IEC 61730. The application class is A, meaning the modules can be used in system of 50Vdc or 235W or higher, to which the general public may have access. Emrys's modules also meet the requirement of IEC61730-1 and ICE 61730-2 and qualified for Safety Class II.

4.1 Transportation & storage safety

Do not open the original package during transportation and [2022.01 B0](#)

objects into the connector, or modify them in any way in order to secure an electrical connection.

Do not touch the modules which junction box is failed off or other damaged unless the modules are disconnected in advance and you are wearing proper PPE. Avoid handling modules when they are wet unless cleaning the modules as directed in this manual. Never touch electrical connections that are wet, without PPE or insulated gloves.

Reflection from snow or water can increase sunlight and therefore increase current and power. In addition, low environmental temperature can also substantially increase voltage and power.

4.4 Fire safety

Consult your local authority for laws and codes;

Roof constructions and installations may affect the fire safety of building, it has to be covered by fire-proof material with appropriate class, and



make sure there is adequate ventilation between back sheet and installation side. In order to maintain the fire class rating, supporting plate (aluminum or epoxy resin) needs to be added on the back of the modules; modules are electrical generating devices that may affect the fire safety of a building.

Electric arc may happen when module working due to the wrong installation method or defective module part. Please keep the combustible liquid, gas and dangerous cargo away from the module. You must stop using the module if there is exposed combustible gas nearby.

In the event of a fire, modules may continue to produce a dangerous DC voltage, even if they have been disconnected from the inverter, have been partly or entirely destroyed, or the system wiring has been compromised or destroyed. In the event of fire, inform the fire crew about the particular hazards from the PV system, and stay away from the PV system during and after a fire until the necessary steps have been taken to make the PV system safe.

5.INSTALLATION

5.1 Installation condition

Emrys's modules must be mounted on buildings or other structures suitable for modules installation (e.g. ground, rooftop). Modules can be installed in seaside with a distance of 50m to 500m from sea. Corrosion may happen to joints between frame and supporter, or and grounding; Must use stainless steel or aluminum metal to directly contact modules

2022.01 B0

in seaside and do antiseptic treatment on joints to prevent corrosion; Modules must not be installed, nor operated in area with strong corrosive matter, such as salt, salt mist, salt-water, active chemical vapors, acid rain, any other type of corrosive matter. In addition, Modules must not be sit in locations where hail, snow, sand, smoke, air pollution, soot, etc. are excessive, this could affect the safety and/or performance of the modules.

The recommended ambient temperature should be within – 40°C to 40°C. Do not apply mirrored, magnifiers or other concentrate light onto the modules.

Emrys recommends installing the modules with a tilt angle of at least 10 degrees, making it easier for dust to be washed off by rain and reduce the time of cleaning; In addition, this will help to drain the water out directly from the surface, avoid watermarks from trapping water on the modules surface and affect the appearance and performance of modules.

Partial or complete shading of a module or modules can significantly reduce system performance. Emrys recommends installing modules in the place without shade throughout the year to increase the amount of energy produced by the modules; Lightning protection is recommended for PV systems that are to be installed in locations with high probability of lightning strikes.

In the northern hemisphere, modules should typically face south, and in the southern hemisphere, modules should typically face north; For detailed information on the best installation angle, please refer to standard solar photovoltaic installation guides or consult a reputable solar installer or systems integrator.

5.2 Mechanical installation

Ensure that the installation method and supporting system of modules is strong enough to make the modules to be able to withstand all the pre-established load conditions. The installer must provide the guarantee. The installation supporting system must be tested by the third-party organization with the analysis ability of Static Mechanical, according to the local national or international standards such as DIN1055 or equivalent standards.

The modules mounting structure must be made of durable, corrosion-resistant and UV-resistant material; Modules must be securely attached to the mounting structure; In regions with heavy snowfall in winter, select higher mounting system. So that the lowest edge of the modules will not be covered by snow for long time. In addition, ensure that the lowest portion of the modules is placed high enough so that it will not be shaded by plants or trees, or damaged by flying sand; Because

www.emrys-solar.com

of thermal and expansion of the module frames, must ensure that the minimum distance between neighboring frames is 10mm.

5.2.1 Installation onto flat or curved surface



Cleaning the surface carefully and spreading the structural adhesive on it along the longitudinal direction of the modules. Adhesive column should roughly follow the area of 1830mm long, 6~10mm wide, 3~5mm thick, and have the gap of 250mm between each other. Sticking the Lohmann double-sided tape of 1780mm long and 17mm wide onto each long edge of the modules to prevent falling off before the structural adhesive solidified(recommend to use International tape brand like Lohmann etc.). In order to achieve the best bonding performance, it is required to install the modules within 5 minutes once the adhesive is applied on the wall. Then pressing the modules gently against the surface (screws could also be applied as auxiliary method as per customer's requirements). The gap between each module shall be kept around 1cm.

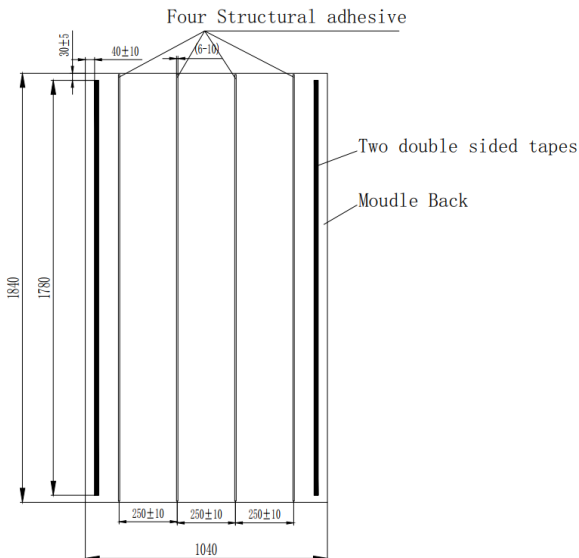

5.2.2 Installation under the low load situations

In order to install flexible modules under low load situations, a supporting plate (aluminum or epoxy resin) needs to be added on the back of the modules. The size of the plate shall be no less than the size of the module to ensure the fully support and stability of module installation, and avoid PV module damage caused by local stress and load. It's recommended to use double-sided tape or industrial structural adhesive (minimum 5 min for surface dry and no less than 24 hours for complete solid needs to be considered) to bond the module with the plate. The installation can be done by industrial structural adhesive or screw. If by screw mounting, you need to perforate threaded holes of 5mm diameter according to the positions on the module.

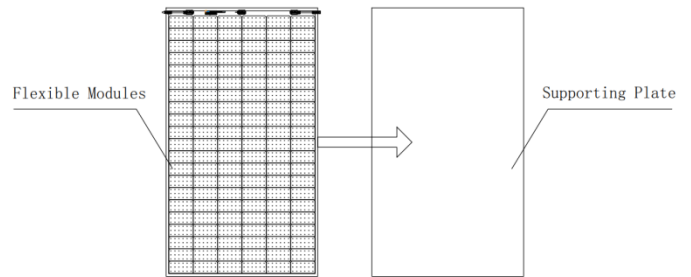

5.2.2.1 Installation via industrial structural adhesive

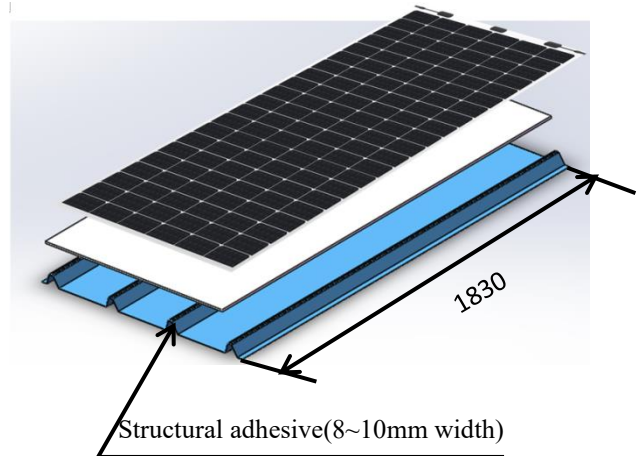

Take tin roof for example, when installing, first inject the industrial structural adhesive to the heave part on 4 tapes of 1830mm long and 8~10mm wide. Laying the flexible modules on the treated surface (see the above picture) and pressing gently against the tile. In order to achieve the best bonding performance, please install the modules within 5 minutes before the adhesive is solidified.

5.2.2.2 screw mounting

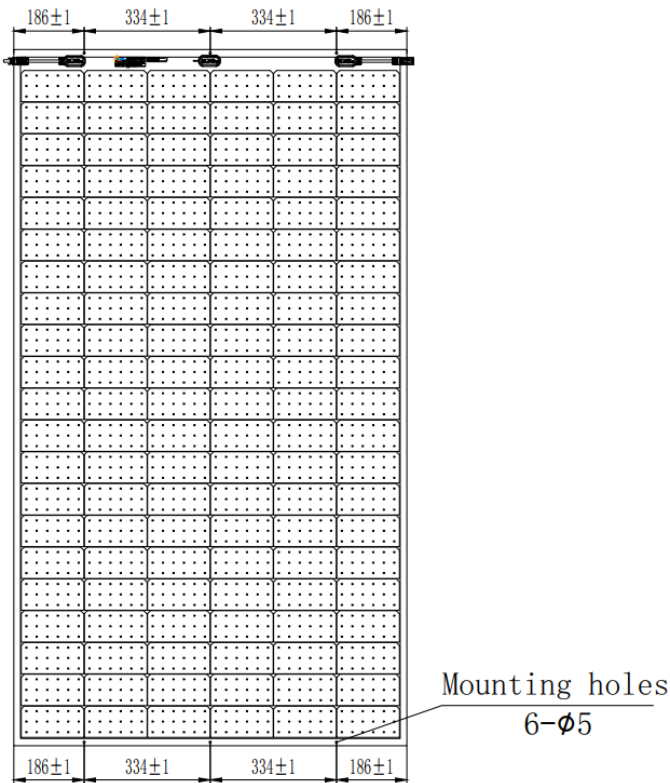

Drilling 6 mounting holes on the module as shown above (the holes' position could be customized as per customer required). The holes' position must keep safe creepage distance away from the solar cells and junction box. Creepage distance depends on the type of modules (Minimum creepage distance is at least 15mm).

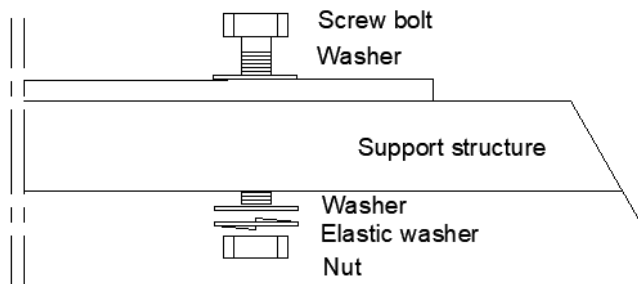

Fixing the modules to the mounting bracket by screws and bolts, as shown above. Screwing up the module at all 6 positions.

5.2.3 Please contact with Emrys for any installation method not mentioned as above. Emrys bears no responsibilities for such loss caused by improper installation. 5.3 Electrical installation

The deviations always exist between the nominal value and test value in standard test condition of Rated electrical characteristics of module such as I_{sc} , V_{oc} and P_{max} , Standard Test Conditions: 1000 W/m^2 Irradiance, 25°C Cell Temperature and 1.5 Air Mass, normally, the value of current

and voltage generated from Modules will be probably higher than values under standard test condition. When determining module voltage ratings, conductor current ratings, fuse sizes, and size of controls connected to the PV output, on the basis of highest local temperature, combine with temperature coefficient of current in manual, I_{sc} can be calculated by multiplying by the coefficient of 1.25; On the basis of lowest local temperature, combine with temperature coefficient of voltage in manual, V_{oc} can be calculated. When modules are in series, voltage to be added up; when modules are in parallel, current to be added up. PV modules with different electrical properties can't be connected in series, different electrical components of modules may cause mismatch of electrical connection, make sure to install them in accordance with manual provided by manufacturer.

5.3.1 Connection type

The maximum number of modules that can be connected in a series string must be calculated in according with applicable regulations in such a way that the specified maximum system voltage (According to IEC61730 tests and appraisal, the maximum system voltage is 1000Vdc or 1500Vdc depending on the series and model.) of the modules and all other electrical DC components will not be exceeded in open circuit operation at the lowest temperature expected at the PV system location. Correction factor for the open-circuit voltage can be calculated based on the following formula: $V_{oc} = 1 - \beta V_{oc} \times (25 - T)$. T is the lowest expected ambient temperature at the system location. β (%/°C) is the temperature coefficient of the selected module V_{oc} (Refer to corresponding datasheet).

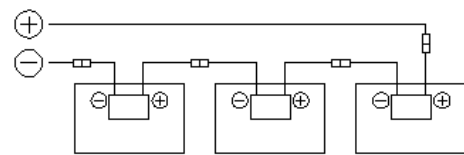

Series wiring

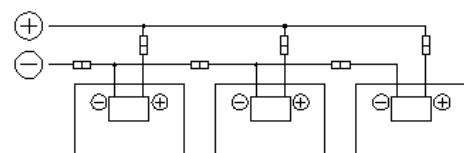

Parallel wiring

An appropriately rated over-current protection device must be used when the reverse current could exceed the value of the maximum fuse rating of the modules. An over-current protection device is required for each series string if more

than two series strings are connected in parallel.

These junction boxes have been designed to be easily interconnected in series for their good connected cable and the connector with IP68 protection grade. Each modules has two single conductor wires, one positive and one negative, which are pre-wired inside the junction box. The connectors at the opposite end of these wires allow easy series connection of Emrys's modules by firmly inserting the positive connector of a module into the negative connector of a Emrys module until the connector is fully seated.

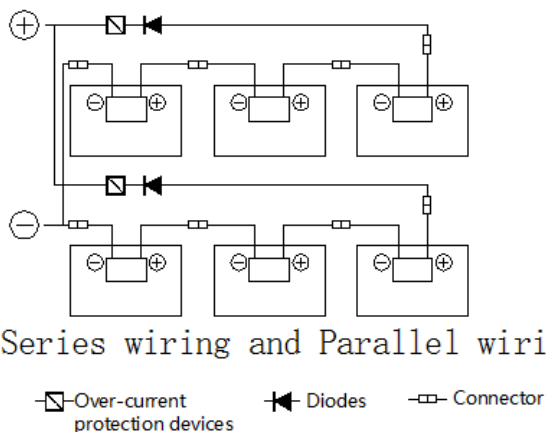

5.3.2 Cables

Use field wiring with suitable cross-sectional areas that are approved for use at the maximum short-circuit current of the module. Emrys recommends installers use only sunlight resistant cables qualified for direct current (DC) wiring in PV systems. (Satisfy the code TÜV 2 PfG 1169、4mm²、Temperature range:-40°C to +90°C); Cables should be fixed to the mounting structure in such a way that mechanical damage of the cable and/or the modules is avoided; Do not apply stress to the cables; For fixing, use appropriate means, such as sunlight resistant cable ties and/or wire management clips specifically designed to attach to the modules frame. While the cables are sunlight resistant and waterproof, where possible, avoid direct sunlight exposure and water immersion of the cables.

5.3.3 Connectors

Keep connectors dry and clean, and ensure that connector caps are hand tight before connecting the modules. Do not attempt to make an electrical connection with wet, soiled, or otherwise faulty connectors. Avoid sunlight exposure and water immersion of the connectors. Avoid allowing connectors to rest on the ground; Faulty connections can result in arcs and electrical shock. Check that all electrical connections are securely fastened. Make sure that all locking connectors are fully engaged and locked.

2022.01 B0

5.3.4 Bypass diodes

The junction boxes used with Emrys's modules contain bypass diodes wired in parallel with the PV cell strings. In the case of partial hot spot, the diodes bypass the current generated by the cells with hot spot, thereby limiting modules heating and performance losses. Bypass diodes are not over-current protection devices. In the event of a known or suspected diode failure, installers or maintenance providers should contact Emrys. Never attempt to open the junction box by yourself.

6.MAINTENANCE AND REPAIR

Emrys recommends that PV systems shall be periodically inspected by the installer or qualified person.

6.1 Maintenance

Whether the front cover is broken; Whether there is burning vestige on the backsheet; All cables and connector attachments are undamaged and properly secured; Mounting and grounding components are tightly secured with no corrosion.

6.2 Repair

In order to reduce the potential for electrical and thermal shock, Emrys recommends cleaning modules during early morning or late afternoon hours when solar radiation is low and the modules are cool, especially in regions with high temperatures.

When modules are working, there should not be environmental influence factors to cast shadows and cover part or even all of the modules, such as other modules, system support, bird drops and a lot of dust, clay or plant and so on, these may distinctly reduce the power output. Emrys advises that there should be no obstructed object over the modules surface at any time.

The cleaning frequency depends on the accumulated frequency of the fouling. In many instances the front surfaces of the modules will be cleaned with the rain, and we can decrease the cleaning frequency; In order to avoid module damage, do not clean PV modules with a power washer or pressure washer, it is recommended to wipe the modules surface with a wet sponge or soft cloth. Please do not clean the modules with a cleaning agent which contains acid or alkali; However, if removing snow is desired to enhance production, use a brush to gently remove snow; Do not try to remove frozen snow or ice from THE modules.

7.MODEL RANGE

The installation manual applicable module types are as

www.emrys-solar.com

follows. The module types are subject to changes without prior notice due to continuous product innovation, research and development. “XXX” shows the peak power of the module Label in increment of 5.

Module type	Power	Dimension (L×W×H)
	W	mm
ESXXX-FLEX	365~385	1840 × 1040 × 2.5

8.CONTACT

Emrys Solar Co., Ltd.

Addr.: No. 12A04, B-1 Area, Taifu City, No. 19

Guangdian Middle Road, Hutang, Wujin, Jiangsu, China.

E-mail: info@emrys-solar.com

www.emrys-solar.com